

Sonja

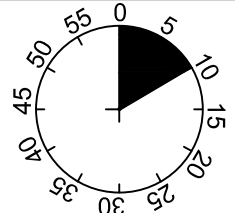

1

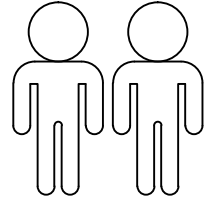
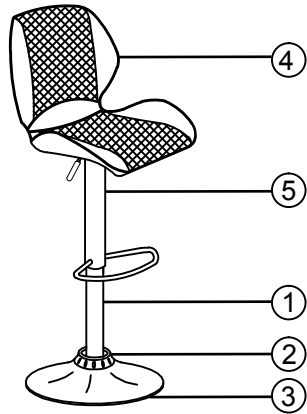

2



3



4

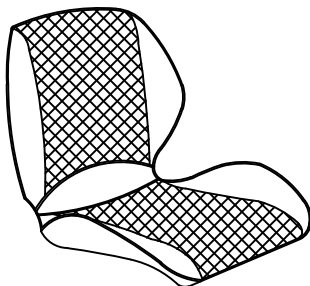

5

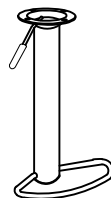

| | |
|---|----|
| 1 | 1x |
| 2 | 1x |
| 3 | 1x |
| 4 | 1x |
| 5 | 1x |

A

M6X20



2x

B

M6x30



2x

C

Ø18xØ6x1.5



4x

D

Ø18xØ8x10



2x

E

4MM



1x

I.



1

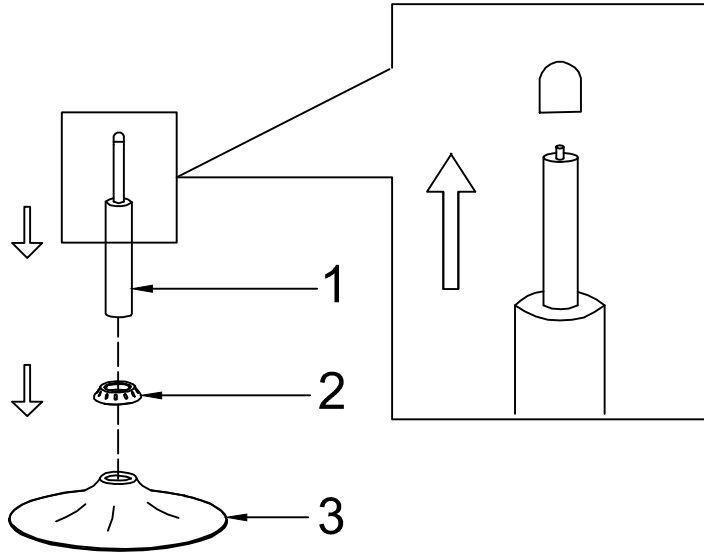

2

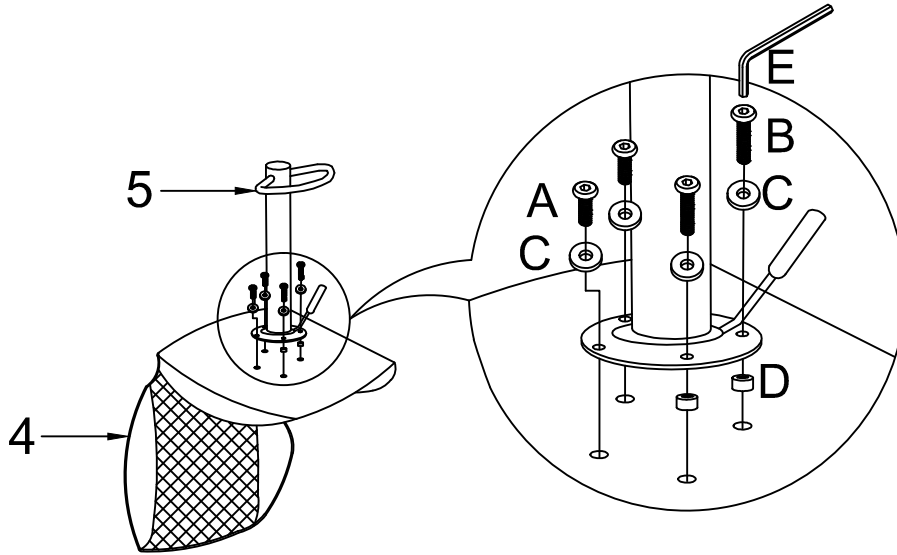

| | |
|---|------------|
| A | M6x20 |
| | |
| | 2x |
| B | M6x30 |
| | |
| | 2x |
| C | Ø18xØ6x1.5 |
| | |
| | 4x |
| D | Ø18xØ8x10 |
| | |
| | 2x |
| E | 4MM |
| | |
| | 1x |



3

